

Specialists in Manufacture of
Critical Spare Parts for
Combers



CHUNG HIN CO.,LTD

บริษัท สร้อยปิ่น จำกัด

778 ถนนเจริญนคร แขวงบางปะกอก

เขตราชบุรีบูรณะ กรุงเทพฯ 10140

โทร.02-877-6583,877-6584 แฟกซ์ 02-877-6582

TEX-TECH

INDUSTRIES (INDIA) PRIVATE LIMITED





PROFILE

Tex Tech Industries (India) Pvt Ltd was started in the year 1975 as a Partnership company by Late. Shri. S. Srinivasan to manufacture Spare parts for cotton combers. It was the first company to manufacture New Nipper Assemblies in India.

Tex Tech specializes in manufacture of Hi-performance Retrofit kits to up-grade older generation Combers to the latest 4th generation for achieving optimum removal of noils along with improved yarn quality levels.

Tex Tech is the only company to manufacture all types of technological Spare parts as OEM replacements for all models of Combers.

Tex Tech carries stock of spare parts for all combers and serves the Textile industry by immediate supply at competitive rates.

Tex Tech has a global presence with exports to countries like China, Egypt, Turkey, Indonesia, Vietnam, Argentina, Italy, Spain, Peru, Brazil, Bangladesh, Thailand, Iran, Pakistan, USA etc.,

Tex Tech's state of art infrastructure in terms of manufacturing facility is a perfect example of fusion between 40 years of expertise with progressive technologies. This concept of Continuous improvement coupled with an earnest desire to be among the best keeps us pushing forward.

Tex Tech is also an OEM supplier of spare parts for a leading European Manufacturer.

Tex Tech is also into production of Green Energy by installing its Own Wind Mills.





HI-PERFORMANCE NIPPER ASSEMBLIES FOR ALL TYPES OF COMBERS

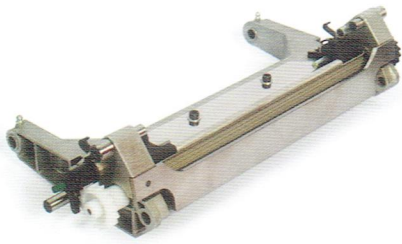

E7/5, E7/5A, E7/6, E60, E60H, E70R, E62, E65
& E66 NIPPER ASSEMBLY

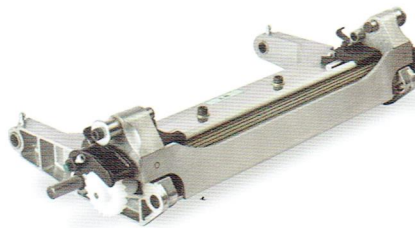

E80, E86 NIPPER ASSEMBLY

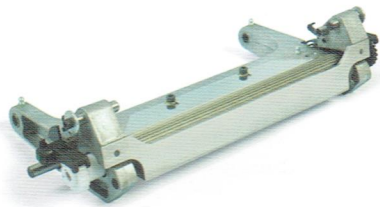

LK54, LK64 NIPPER ASSEMBLY

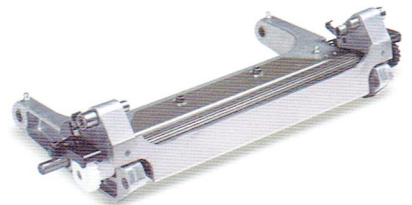

LK64Z, LK69 NIPPER ASSEMBLY



CM 500, CM 600 &
CM 600N NIPPER ASSEMBLY

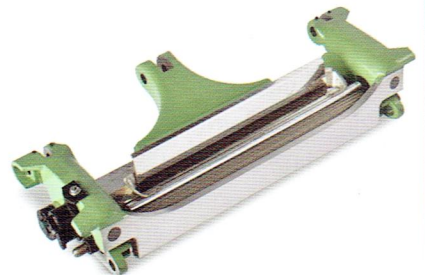

LR E7/4 & LK250 NIPPER ASSEMBLY

BENEFITS :

- Ultra Light weight Construction
- Improved clamping area (3.5mm) ensures Process of Heavier Lap weights (80 g/mtr)
- Cryogenic treatment for extended life



MIRRA COMBS

HI-PERFORMA

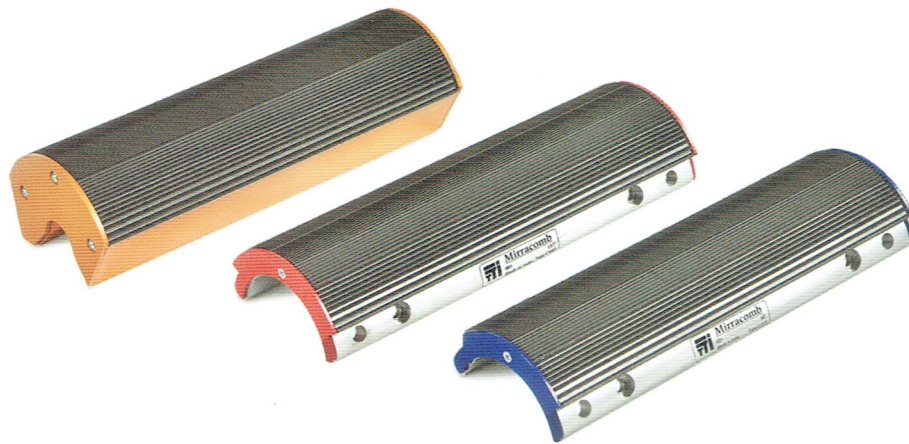

BENEFITS:

- Progressive distribution of wire points and optimum tooth geometry for better NRE%
- High precision in manufacturing guarantees perfect setting between nipper and unicomb



Mirra Comb I 40 - 130 deg.

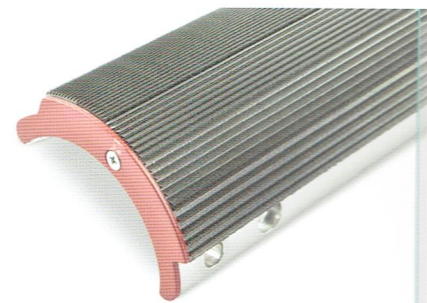

Mirra Comb 514 - 90 deg.



Mirra Comb 815 - 90 deg.

MODELS available :

- Mirra Comb 140 F - 90 deg, 111 deg
- Mirra Comb 149, 514, 715, 525 - 90 deg.
- Mirra Comb 814, 815, 915 - 90 deg (Conical in feed)
- Mirra Comb 515 - 111 deg.
- Mirra Comb 585 - 118 deg.
- Mirra Comb I 40, I 50 - 130 deg.

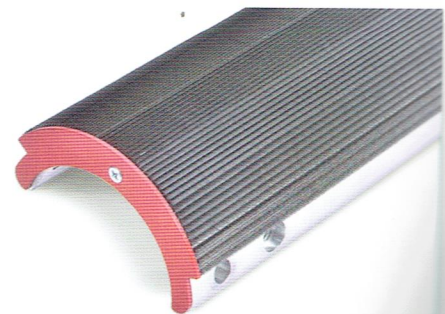

Mirra Comb 585 - 118 deg.



MIRRA TOP COMBS



BENEFITS :

- Reduction in top comb loading due to improved design of needles
- Heavier Lap weight can be processed due to improved needle strength
- Superior finish, hence no accumulation of micro dust on plates

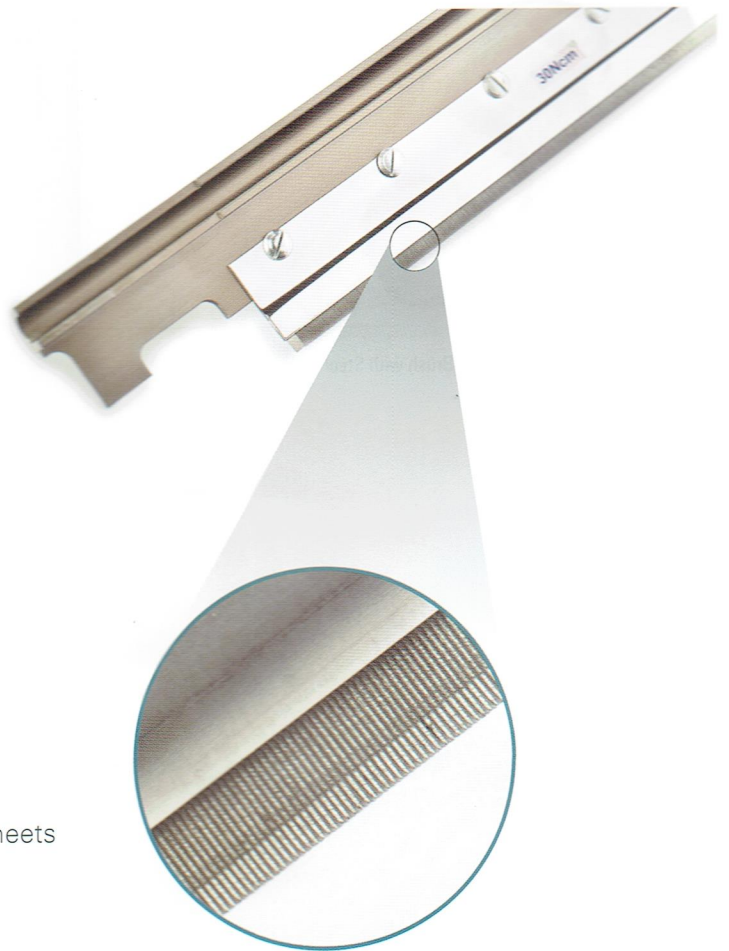
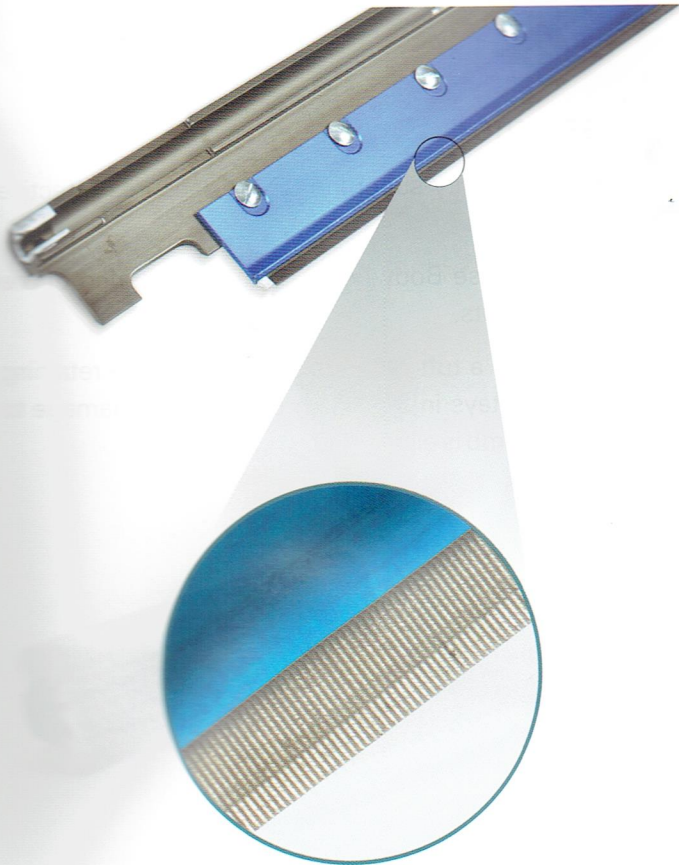

FEATURES

- Hardened needles are firmly mounted on Spring steel sheets & Aluminium Alloy Extruded sheets
- Never Bend even under extreme loads
- No fall out of needles during working
- Variable Density of - 23, 26, 28 & 30 NCM are available



MEXICAN FIBRE BRUSH WITH ABS BASE



BENEFITS :

- First quality superfine bristles ensures effective cleaning.
- ABS Base Body helps in solid anchoring of the fibre tufts.
- Even if a tuft of bristles is torn out the retaining wire stays in the brush base, hence damage to Unicom is eliminated.



Brush with Steel Wire



Mexican fibre Brush with
ABS Base



Crocodile Tooth ABS Base
Brush with extra stiff fibre

FEATURES:

- Mexican Fibres with Extra stiffness and lesser resilience enhances cleaning efficiency.
- Crocodile tooth design eliminates buckling of brush base even at high working speeds



SPIRAL CLEARER ROLLERS

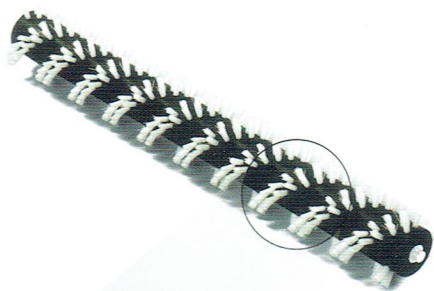

BENEFITS :

- Better removal of fringe fibres and flies from Top detaching rollers due to abrasive grit.
- Excellent resilience is achieved due to the special grade Nylon fibres .
- Long life due to superior quality of pinning & trimming (automation process).



Special Polyamide fibre
for Perfect Cleaning

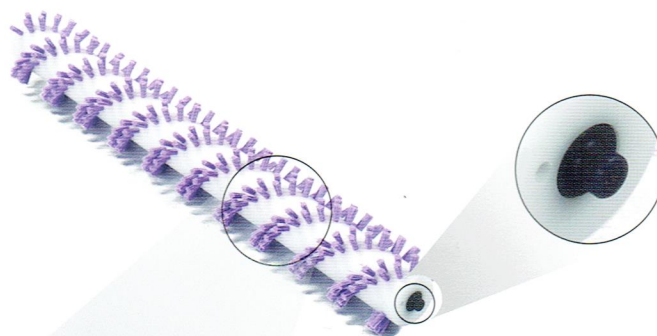

Abrasive resistant side pin

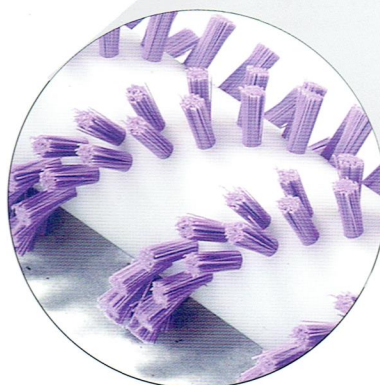

Special Polyamide fibre with **abrasive grits**
for Superior Cleaning

MODELS :

Spiral Clearer Rollers are available for E7/4, E7/5, E7/5A, E60, E60H, E62, E72, E65, E75, E66, E76, E80, LK54, LK64, LK64 Z & LK69 Combers.



METALON SPOOLS

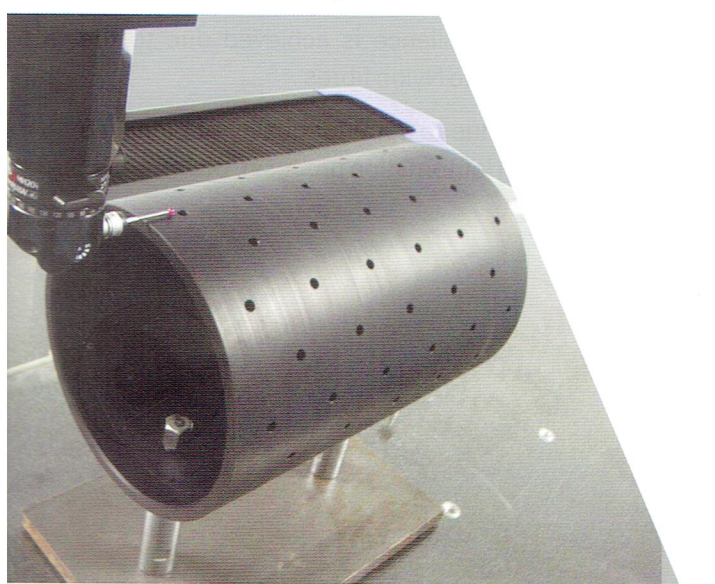

CMM Inspection ensures Stringent quality Levels

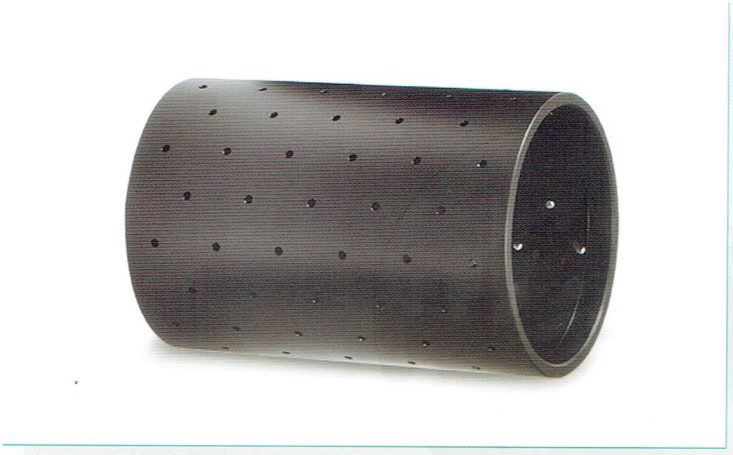

CNC Machined for High Accuracy Levels

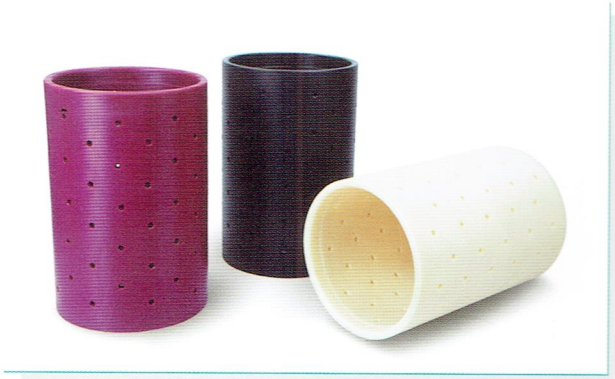

Different Colours for count identification

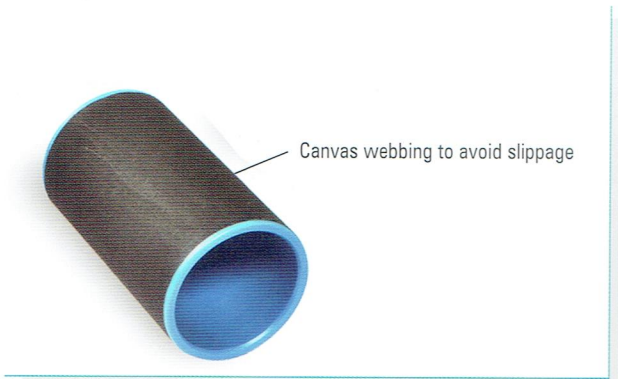

Canvas webbing to avoid slippage

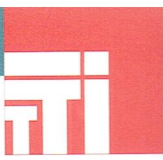

HI-PERFORMANCE TOP COMB HOLDERS

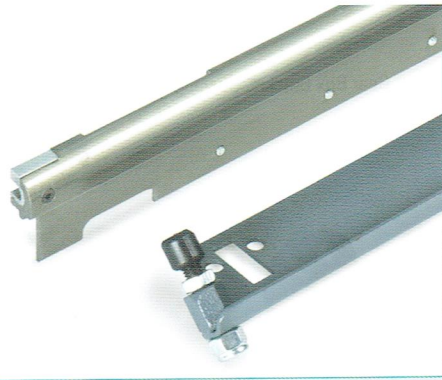
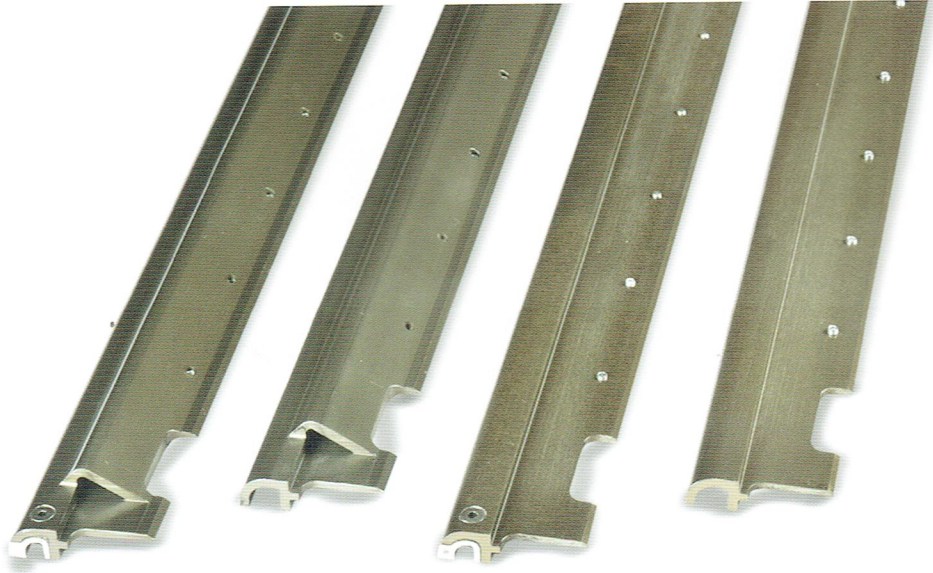

Anti wear Top comb holder with APK for
E7/5, E7/5A, E7/6, E60, E60H & E70R Combers



Vibration Free Anti wear Top comb holder with APK for
E66, E76 & E80 Combers



Anti wear Top comb holder with APK for
LK54, LK64, LK64Z & LK 69 Combers

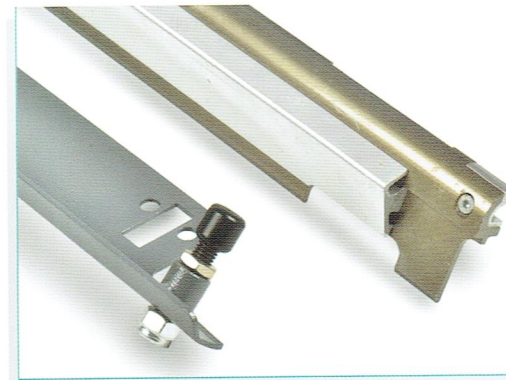

Vibration Free Anti wear Top comb holder with APK for
E60H, E70R, E62, E72, E65 & E75 Combers



GEAR BOX PARTS FOR E7/5, E7, 5A, E7/6, E60, E60H, E70R, E62, E72, E65, E75, E66, E76 & E80 COMBERS

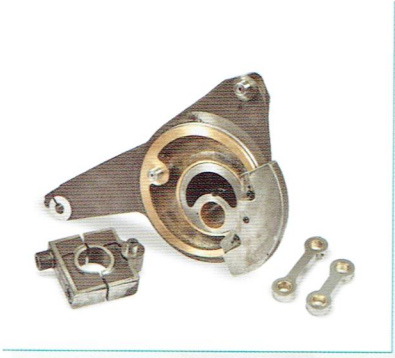

Swivelling Lever, PB Cam, Eccentric Bearing,
Connecting Rods, Eccentric Weight, Swing Arm



Main Bearing, Control Disc, Cross Head,
15 T Comb drive shaft



Hardened & Profile Ground Steel gears



Gear Box Bracket, Spacing Ring and Crank Arm



Differential gear assembly (Forged Steel)



Hardened & Profile Ground Steel gears

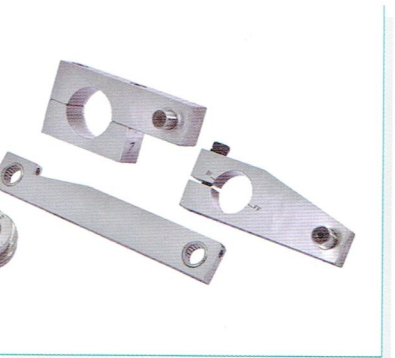

Lever arm top, Lever arm below, Gauge Disk for
Eccenter Adjust & Coupling Arm assembly



Dampening Weight and Top Roller Shell
Top & Bottom (Dead Weight)

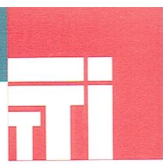

DRAW BOX, DRAFTING & COILER PARTS FOR E7/5, E7, 5A, E7/6, E60, E60H, E70R, E62, E72, E65, E75, E66, E76, E80 COMBERS

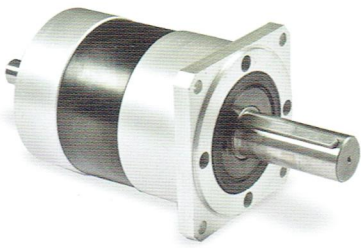

Coiler Gear Box for E60, E60H & E70R

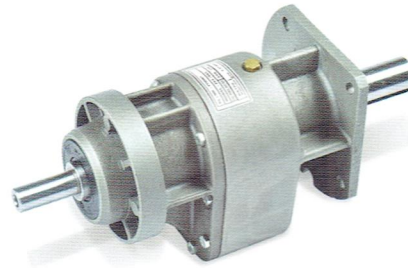

Coiler Gear Box for E62, E72, E65, E75, E66 & E76

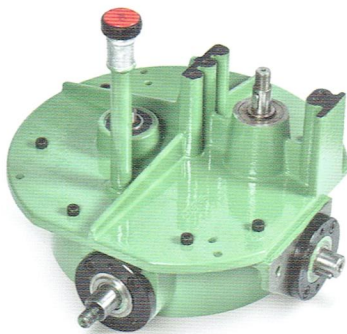

Coiler Gear Box for E7/5, E7/5A & E7/6



SPV 55 Gear Box for E7/5, E7/5A & E7/6

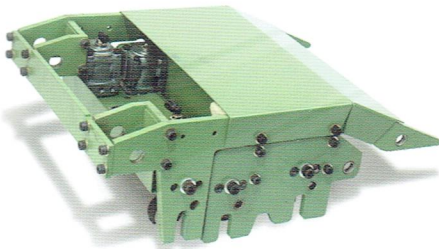

E62 Type Draw Box (3 over 5)

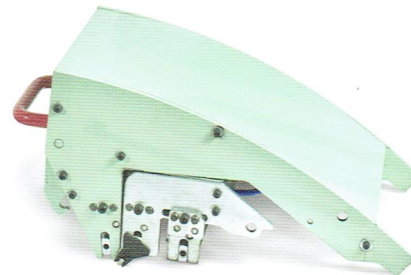

E66 Type Draw Box (3 over 3)

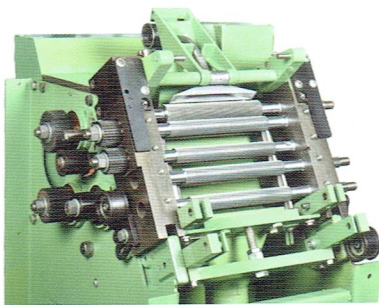

E62 Type Drafting Unit (3 over 5)

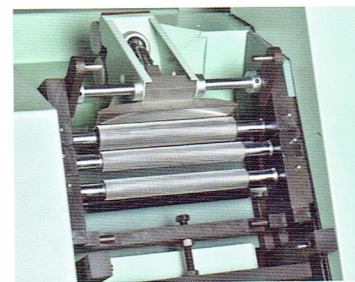

E66 Type Drafting Unit (3 over 3)



LONGITUDINAL PARTS FOR E7/5, E7, 5A, E7/6, E60, E60H, E70R, E62, E72, E65, E75, E66, E76 & E80 COMBERS



Alufit Top rollers with end bushes



Bottom Fluted rollers (Parabola)



Top comb Holders (Hardened Aluminum)



Polyurethane Strippers

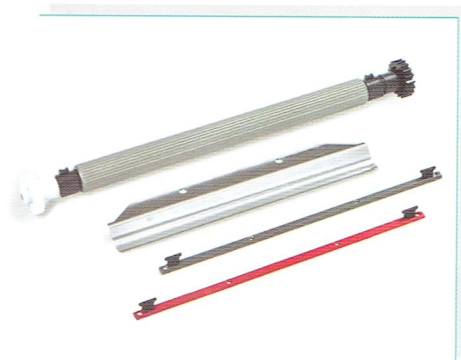

Feed Roller, Fleece guide and Pressure Bars



LP Bridge Plates (Web Bowl)

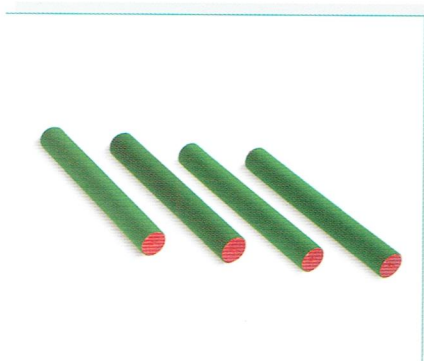

Flocked Clearer Rollers



Top stripper, Wiper support, Pressure Bar, Holders

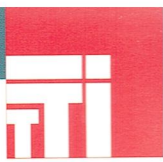

HI PERFORMANCE POLYMER PARTS FOR E7/5, E7, 5A, E7/6, E60, E60H, E70R, E62, E72, E65, E75, E66, E76 & E80 COMBERS



Nylon Parts in Original Virgin Material

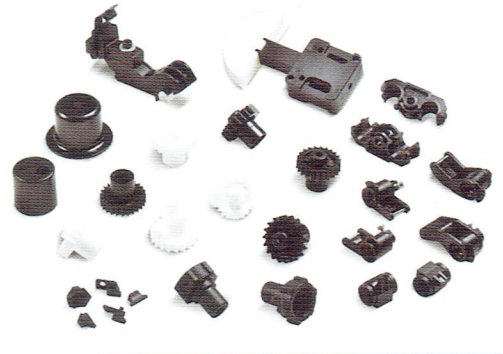

Nylon Parts in Original Virgin Material



Lap Tension Plate (ABS)

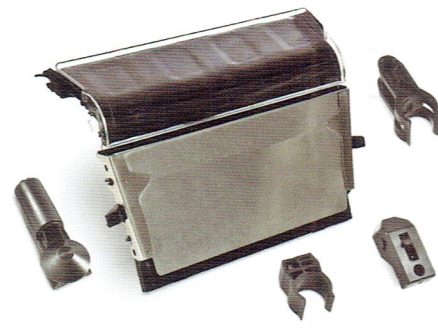

Lap Tension Plate & Robo Lap Parts



Cover hood, Lap guide & Cylinder Cover

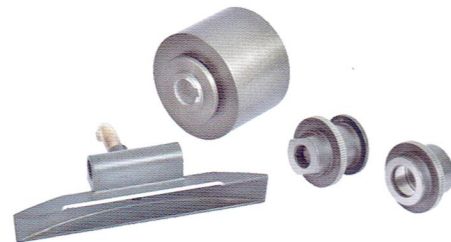

Roller dia 98.5mm, Delivery Trumpet & Waved rollers



Condensors



Hardened & Profile Ground Steel Gears



LONGITUDINAL PARTS (ALUMINIUM PDC) FOR E7/5, E7, 5A, E7/6, E60, E60H, E70R, E62, E72, E65, E75, E66, E76 & E80 COMBERS

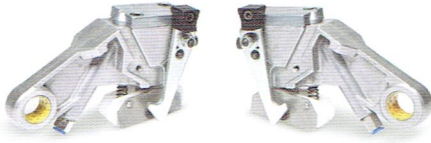

E65 Type Detaching Loading



Nipper Crank, Supporting Bearings, Spring Latch, Front Support, Hinge & Pressure Aggregate

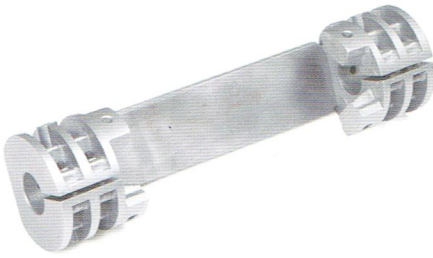

Circular Comb Cylinder Aluminium (PDC)



Bearing Plate, Bearing Plate Head & Clamping Hub

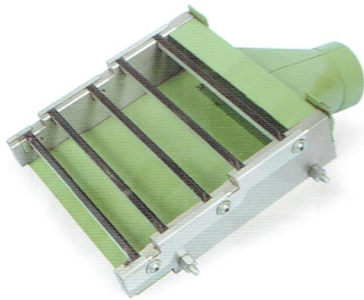

Suction Hood Assembly

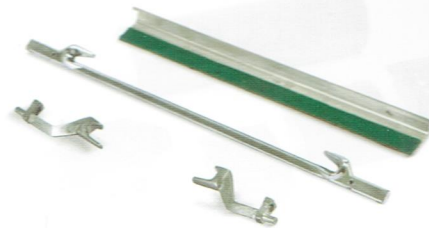

Fleece Guide 301mm, Fleece Guide (Small) & Cleaning Strip

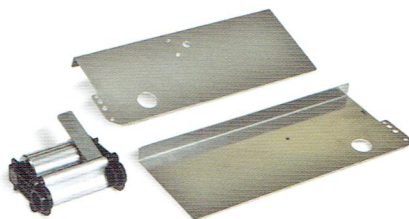

Calender Roller Assembly, Take off table LH & RH



Bearing Block, Driven Roller & Empty Bobbin



GEAR BOX PARTS FOR LK54, LK64, LK64Z & LK69 COMBERS

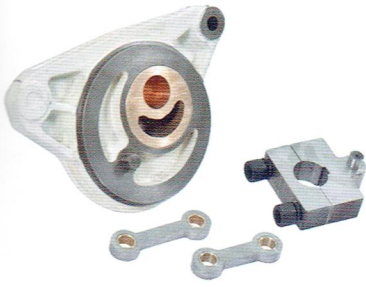

Swivelling Plate, Cam Bearing, Cam, Actuating Lever, Latch 85mm & Latch 105mm

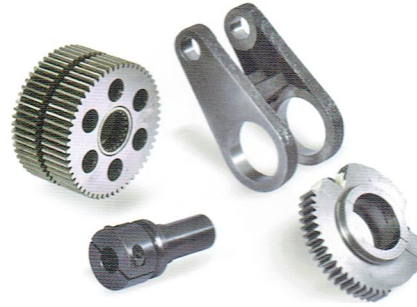

Bracket Arm, Spur Gear 56T, Coupling Main Drive Shaft & 56T Nipper Shaft Gear

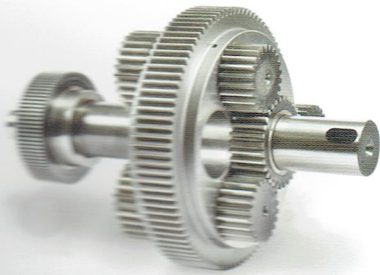

LK54 Differential Gear Assembly in Steel

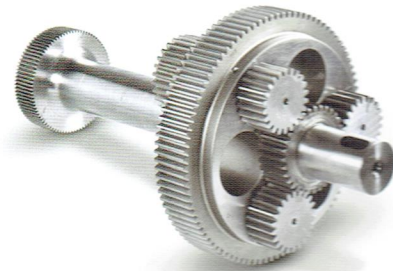

LK64Z, LK69 Differential Gear Assembly in Steel



143T Gear Hardened & Profile Ground



Hardened & Profile Ground Gears in Steel

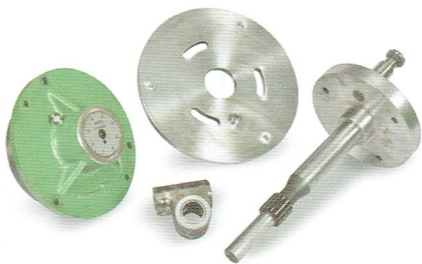

Main Bearing, Control Disc, Cross Head, 15t Control Shaft Assembly

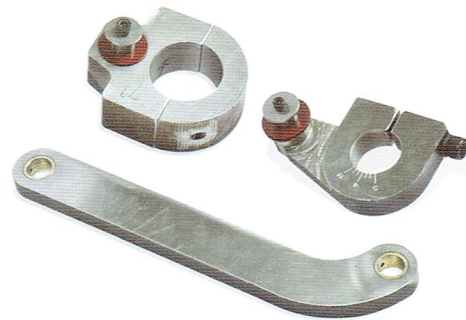

Top Nipper Shaft Link, Coupler For Top Nipper & Crank For Top Nipper



LONGITUDINAL PARTS FOR LK54, LK64, LK64Z & LK69 COMBERS

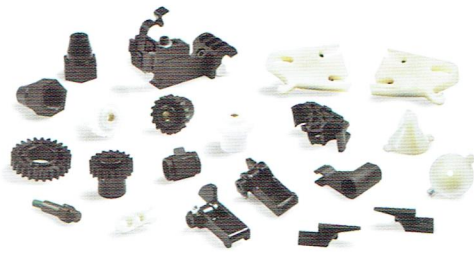

Nylon Parts in Original Virgin Material



Nylon Parts in Original Virgin Material

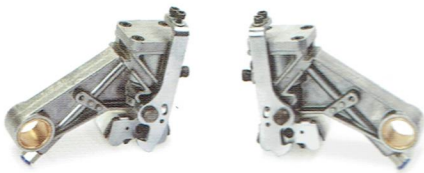

LK64Z Detaching Loading (Aluminium PDC)



LK69 Detaching Loading (Aluminium PDC)

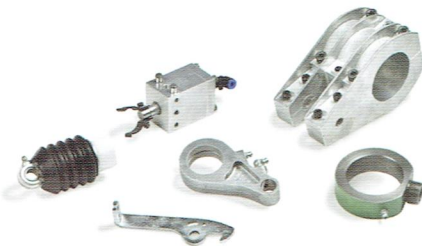

Nipper Crank, Cam Block Front Nipper Support, Pawl Complete Piston Rod Assembly & Threaded Pin Assembly



Nipper Crank, Cam Block Front Nipper Support, Guide Cylinder Lock, Pneumatic Cylinder Assembly & Threaded Pin Assembly



LK54 Feed Roller, LK64Z Feed Roller, Fleece Guide & Stripper Complete



Spiral Clearer Rollers & Adjustable Fleece Guide



LONGITUDINAL PARTS FOR LK54, LK64, LK64Z & LK69 COMBERS



Alufit Top rollers with end bushes



Bottom Fluted rollers (Parabola)



LK64Z Type Web Bowl

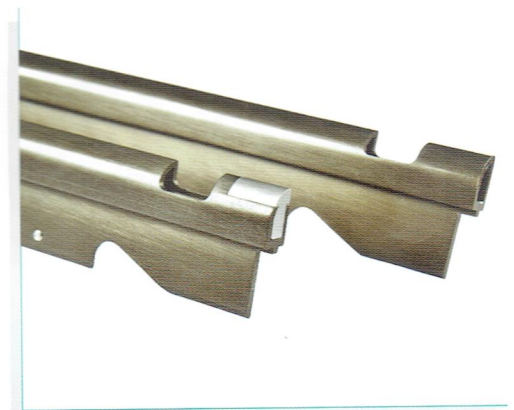

Top comb Holders (Hardened Aluminum)



Swivelling Fleece, Web Deflector LK54 & LK64 Type

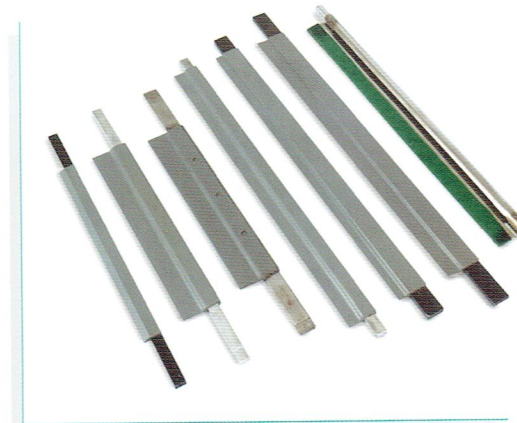

Polyurethane Strippers



DRAW BOX, DRAFTING, COILER PARTS FOR LK54, LK64, LK64Z & LK69 COMBERS

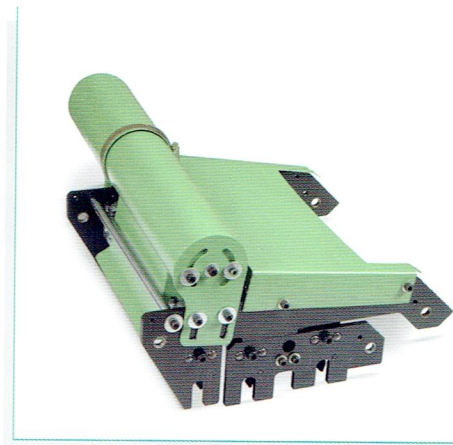

E62 Type Draw Box (3 over 5) for LK54

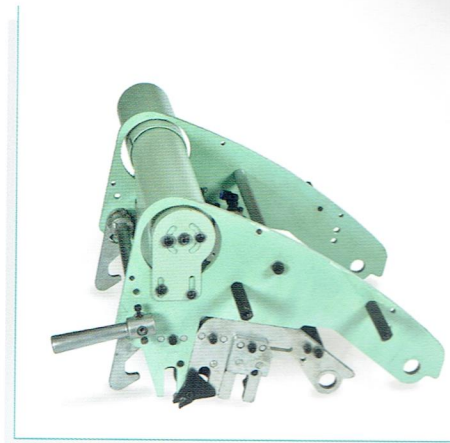

LK64Z Type Draw Box (3 over 3)



E62 Type Drafting Unit (3 over 5) for LK54

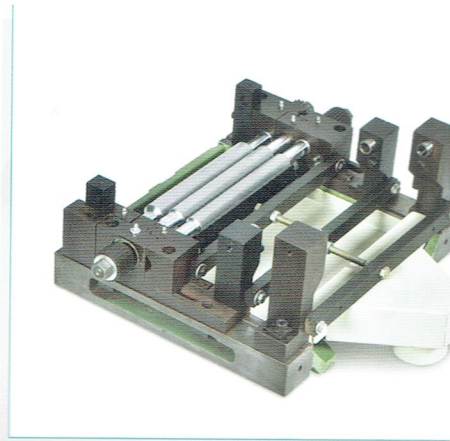

LK 64Z Type Drafting Unit (3 over 3)



LK 54 Coiler Gear Box



Conveyor Roller, Coiler Calender Roller, Bottom Conveyor suction Assembly, Funnel & Coiler Calender



SPARE PARTS FOR CM400, CM400N, CM500, CM600, VC250, VC300 & EC5A COMBERS

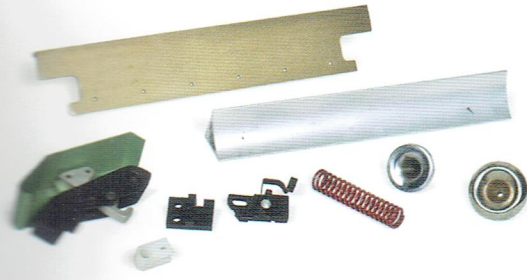

Parts for VC250, VC300, VC300A, VC5 & VC5A



Parts for CM400 & CM400N

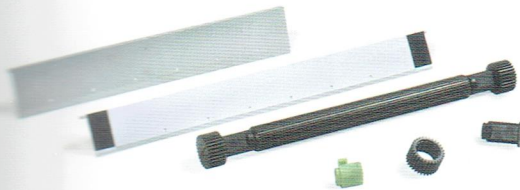

Parts for CM500, CM600 & CM600N

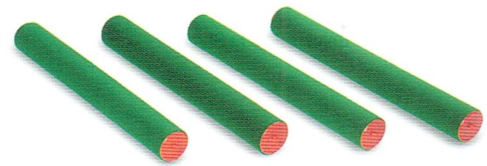

Flocked Clearer Rollers



Gas Springs

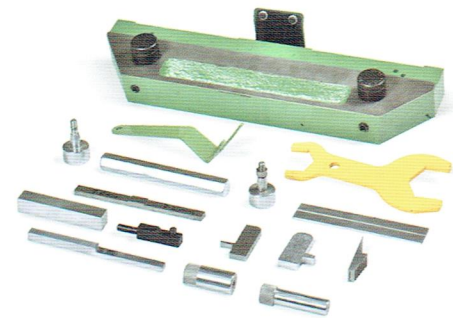

Setting Guages for all models of Combers



Nipper Opening Handle for E7/5A, E7/6, E60, E60H,
E62, E72, E65, E75, E66, E76 & E80 Combers

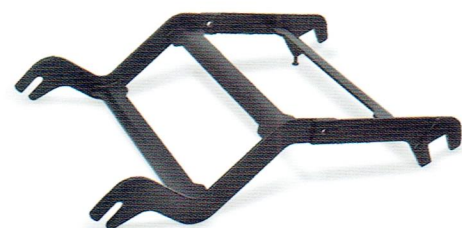

Nipper Opening Handle for LK54, LK64, LK64Z & LK69 Combers



SPARE PARTS FOR UNILAP E5/3A, E30, E32, E34, E35 & E36



Universal Joint Shafts

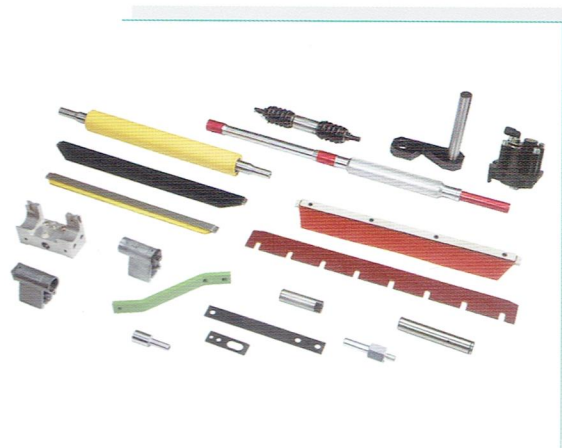

Top Rollers, End Bushes, Loading Elements,
Bearing Saddles, Strippers etc.



Sleeve Carrier



Top Clearer Assembly Parts



Metal Spools



Bottom Fluted Rollers (Parabola)

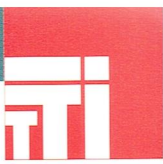

SPARE PARTS FOR SLIVER LAP E2/4A & RIBBON LAP E4/1A

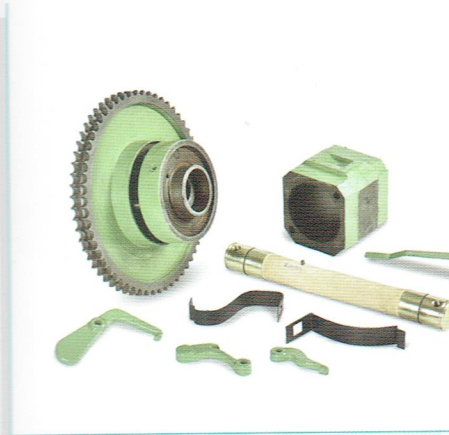

59 T Clutch Assembly, Housing, Pressure Hose & Pawls

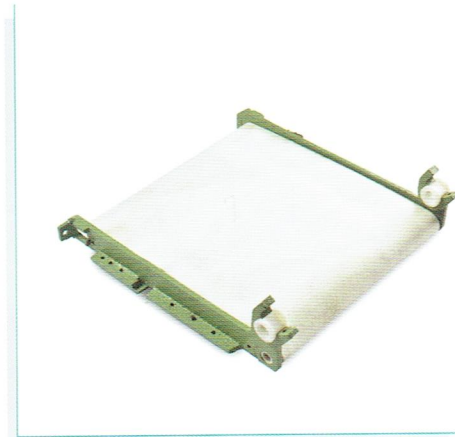

Top Clearer Assembly Complete



Bottom Fluted Roller Drive Studs

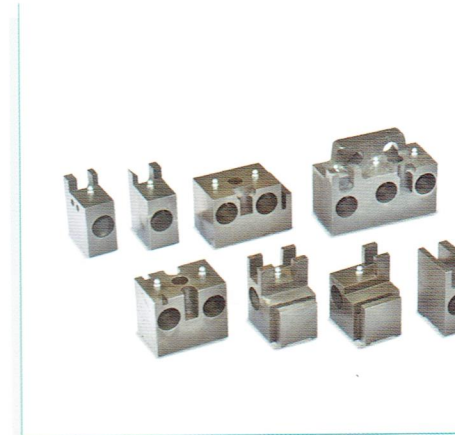

Bearing Saddles



Metalon Spools

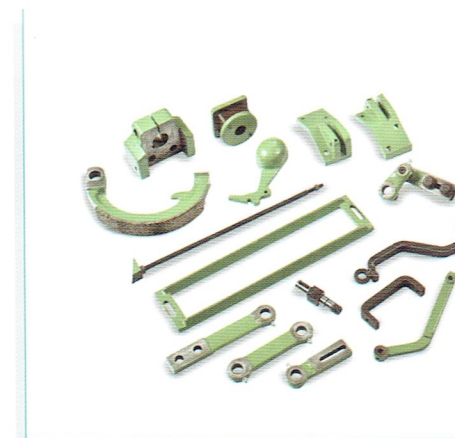

Drafting Zone Spare Parts



ACCESSORIES FOR LAP FORMERS & COMBERS



Lap Trolley for Unilap E5/3A & E30



Lap Trolley for Unilap E32, E34, E35 & E36



Spiral Clearer Roller Cleaning Machine

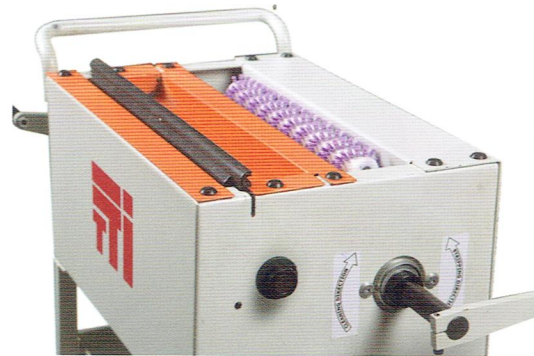

Spiral Clearer & Top Comb Cleaning Machine



INFRASTRUCTURE

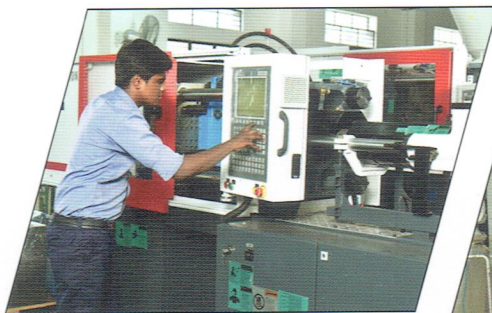
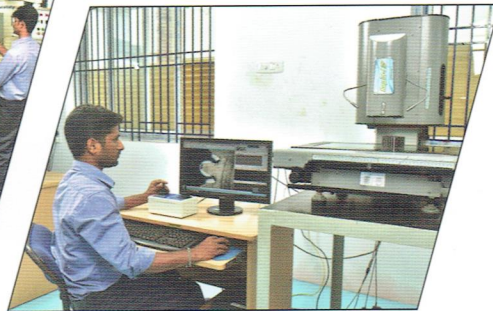
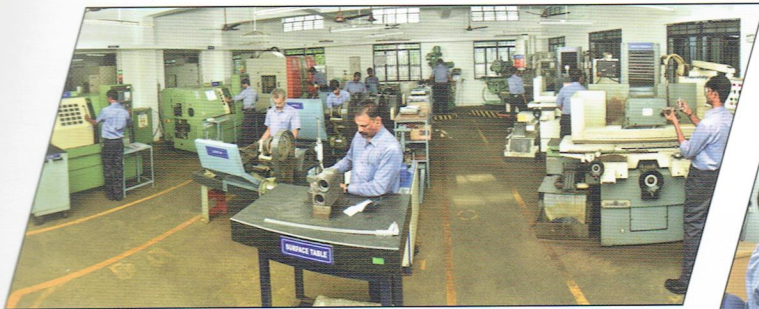

Leading manufacturer of Combers Spares
for Spinning mills world wide as below...



Argentina



Bangladesh



Brazil



China



Egypt



Indonesia



Italy



Iran



Nigeria



Pakistan



Peru



Spain



Thailand



Turkey



USA



Vietnam



TEX-TECH INDUSTRIES (INDIA) PRIVATE LIMITED

27- D, V.N. Industrial Estate, Bharathi Colony,
Peelamedu, Coimbatore - 6410 004. India.
Off : 2566667, 2560078, 2562796. Fax : 00-91-422-2560828.
Email : textech@textechonline.com Web Site : www.textechonline.com

Mfrs : All type of Critical Spare Parts for Combers